

T61 Smart Modem Hardware User Guide

V1.4



Supporting:
Firmware Version: **V20040**
Model: **T61-ELS61**
T61-EHS5

Date: **2020-08-18**

©Copyright 2014, TCAM Technology Pte Ltd. All Rights Reserved.

This document (T61 Smart Modem Hardware User Guide) contains information that is proprietary to TCAM Technology Pte Ltd. No part of this document may be copied, or reproduced in any form or by any means, or transferred to any third party without prior written consent of TCAM Technology Pte Ltd. The content of this document may be revised without prior notice.

Table of Contents

| | | |
|-------|--|----|
| 1 | Introduction | 5 |
| 1.1 | Related Documents..... | 5 |
| 1.2 | Product Label | 5 |
| 1.3 | Certification Test..... | 6 |
| 2 | Device Overview | 7 |
| 2.1 | Key Specification at a glance..... | 7 |
| 2.2 | Block Diagram | 9 |
| 3 | Special Features | 10 |
| 3.1 | Dual IP Connection..... | 10 |
| 3.2 | Self-Recovery | 10 |
| 3.3 | DDNS IP Update | 11 |
| 4 | Hardware Interface Description | 12 |
| 4.1 | Overview | 12 |
| 4.2 | Interface Variant | 13 |
| 4.3 | 4-Pin Micro-Fit Interface..... | 14 |
| 4.4 | SIM Interface..... | 14 |
| 4.5 | Status LED | 15 |
| 4.6 | Antenna Interface | 15 |
| 5 | Mechanics, Mounting and Packaging | 16 |
| 5.1 | Mechanical Dimensions | 16 |
| 5.2 | Mounting T61 Smart Modem | 17 |
| 5.3 | Packaging | 17 |
| 5.4 | Cable connection - T61-EHS5 modem and Landis & Gyr Meter | 18 |
| 6 | Get Started..... | 19 |
| 6.1 | Box Open..... | 19 |
| 7 | Device Configuration | 20 |
| 7.1 | Initial Setup | 20 |
| 7.2 | Switching Between Smart Modem Mode and Normal Modem Mode..... | 23 |
| 7.2.1 | Switch to Normal Modem Mode | 23 |
| 7.2.2 | Switch to Smart Modem Mode | 26 |
| 7.3 | Smart Modem Configuration..... | 27 |
| 7.3.1 | General Guidelines for Smart Modem Configuration..... | 27 |
| 7.3.2 | Mobile Network Operator (MNO) | 29 |

| | |
|---|----|
| 7.3.3 T61 Device Information | 29 |
| 7.3.4 Data Service Center (DSC)..... | 31 |
| 7.3.5 Command Service Center (CSC)..... | 32 |
| 7.3.6 Serial Port Setup | 33 |
| 7.3.7 Recovery Setup | 34 |
| 7.3.8 I/O Setup (Optional Feature) | 35 |
| 7.3.9 Utilities..... | 37 |
| 7.4 Default Settings..... | 38 |
| 7.5 SMS Functions..... | 39 |
| 8 Migration from TMA-M37i, TMA-M55i and TMN-51T | 40 |
| 8.1 Normal Modem Mode | 40 |
| 8.2 Smart Modem | 40 |
| 9 Application Notes | 42 |
| 9.1 T61 Firmware Update | 42 |
| 9.1.1 Direct Wire Firmware Update | 42 |
| 9.1.2 Firmware Update Over-The-Air | 43 |
| 9.2 T61 Digital Input Configuration (Optional Features) | 44 |
| 9.2.1 Connection..... | 44 |
| 9.2.2 Configuration | 44 |
| 9.2.3 Testing..... | 44 |
| 9.3 T61 SMS Features (Optional Feature)..... | 45 |
| 9.3.1 Reset T61 | 45 |
| 9.3.2 Turn ON Digital Output..... | 45 |
| 9.3.3 Turn OFF Digital Output..... | 45 |
| 9.3.4 Configure Server IP and Port | 46 |

1 Introduction

This document explains the hardware related features and functionalities of T61 Smart Modem. It can be applied to all variants of T61 models with minimum differences. The scope of this document includes a brief device overview, detailed feature description, step-by-step device configuration tutorial.

1.1 Related Documents

- [1] T61 Smart Modem Hardware User Guide
- [2] T61 Normal Modem PC Setup Manual
- [3] Center Manager User Guide
- [4] Gemalto® EHS5-E AT Command Set 02.000
- [5] Gemalto® ELS61-E AT Command Set 02.000

1.2 Product Label

The label fixed on the top of the T61 Smart Modem comprises information listed in Table 1.

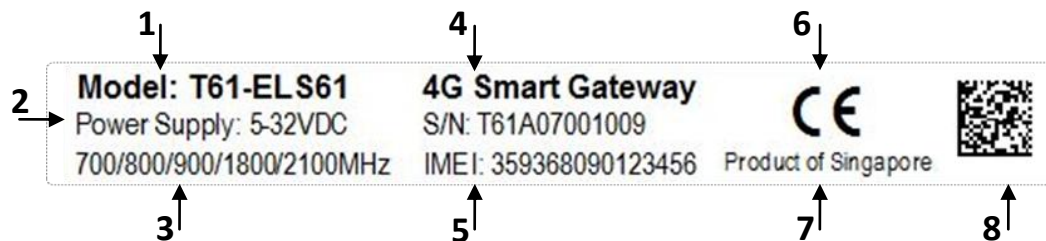

| No. | Information |
|-----|--------------------------------|
| 1 | Model Name |
| 2 | Power Supply |
| 3 | Frequency Band |
| 4 | Device Serial Number |
| 5 | Device Module IMEI Number |
| 6 | CE logo |
| 7 | Marking "Product of Singapore" |
| 8 | Manufacturer Code |

Table 1: T61 Device Logo Information

1.3 Certification Test

T61 is certified for Safety, Emission, ESD, Immunity, RF, EMC, Water/Dust Proof etc, according to the follow standard:

EN60950-1:2006+A11:2009+A1:2010+A12:2011+AC:2011

EN55022:2010/AC:2011

EN55024:2010

EN61000-3-2:2006 + A1:2009+A2:2009

EN61000-3-3:2008

EN62311:2008

EN301 489-7 V1.3.1 (2005-11)

EN301 489-1 V1.9.2 (2011-09)

EN301 489-24 V1.5.1 (2010-10)

EN301 511 V9.0.2 (2003-03)

EN301 908-1 V5.2.1 (2011-05)

EN301 908-2 V5.2.1 (2011-07)

IEC60529:2013 – IP51 Water-proof and Dust Proof

2 Device Overview

T61 is a smart gateway connecting serial devices with RS232 or RS485 interfaces to GSM/GPRS/HSPA/LTE network. It is integrated with a 32bit ARM Cortex-M0+ core processor and a Gemalto 3G or 4G modem module. Equipped with comprehensive features, T61 smart gateway provides industrial standard flexibility, scalability and data reliability.

T61 Smart Modem has two operation modes, namely Normal Modem Mode and Smart Modem Mode. In Normal Modem Mode, T61 functions as a standard 3G or 4G modem by providing a direct serial access to a Gemalto EHS5 or ELS61 module. User could send AT command to achieve various functions, such as SMS, GSM/GPRS/3G/4G connections for data transfer. In Smart Modem Mode, T61 provides a transparent channel from remote end devices to their dedicated data centers. It can be configured as server or client, accept SIM card with dynamic IP or static IP, support TCP/UDP, schedule to connect, connect on demand or “always on” connection, and with Auto Recovery, Re-connection and Redundancy mechanisms.

As compare to PSTN or GSM dial up line or lease line, T61 smart gateway allows you to migrate your remote device from traditional serial communication system to the advance GPRS or 3G/ 4G link, without tedious application development or in depth knowledge of AT command or GPRS/ 3G/ 4G. You can view this device as the “virtual serial wire over the air”, that links all your remote equipment to the central PC. It can be a full transparent, protocol independent gateway, used for AMR, SCADA, general remote monitoring, control and data exchange applications. It is designed for mission critical industrial applications.

Two operation modes:

- **Normal Modem:** The Data Terminal Equipment (DTE, such as PC, PLC, energy meters, controller etc.) is intelligent and can issue various AT commands to T61 normal modem as DCE (Data Communication Equipment) to establish SMS send /receive, GSM/GPRS/HSPA/LTE dial up connection etc.
- **Smart Modem:** In this mode, T61 Smart Modem can be configured with all essential parameters to manage connections. It connects to assigned data centre server automatically upon power up and sets up a transparent serial-to-wireless communication channel between remote devices and data centre. During operation, T61 Smart Modem can maintain the wireless connection and re-establish connection to data centre server in case of connection lost. It can monitor site conditions or connections status, such as signal strength, online/offline etc. It shall be an easy retro-fit solution for existing wired system to 3G/ 4G mission critical wireless system.

2.1 Key Specification at a glance

| Specifications | T61 – EHS5 | T61-ELS61 |
|-------------------|---|-------------------------------|
| General | | |
| Wireless Module | Built in with Gemalto EHS5-E | Built in with Gemalto ELS61-E |
| CPU | 32 bits ARM Cortex-M0+ | |
| Transfer Protocol | TCP/UDP | |
| Operational Mode | Normal Modem ¹ or Smart modem ² (Client or Server mode) | |
| SIM card | 1.8/3V, dynamic or static IP | |

| | | | | |
|------------------------------------|---|--|--|--|
| Internet Connections | Primary : Data Channel Secondary : Command Channel | | | |
| Memory* | 1M Bytes | | | |
| RF Specifications | | | | |
| Frequency Band | GSM/GPRS/EDGE: GSM 900/1800MHz UMTS/HSPA+: UMTS 900/2100MHz | | GSM/GPRS/EDGE: GSM 900/1800MHz UMTS/HSPA+: UMTS 900/2100 MHz LTE: 700/800/900/1800/2100 MHz | |
| Output Power | 2W for GSM/GPRS/EDGE 900MHz 1W for GSM/GPRS/EDGE 1800MHz 0.25W for UMTS (900/2100MHz) | | 2W for GSM/GPRS/EDGE 900MHz 1W for GSM/GPRS/EDGE 1800MHz 0.2W for LTE (700/800/900/1800/2100MHz) | |
| GPRS | Multi-slot class 12 Full PBCCH support Mobile Station Class B Coding Scheme 1 – 4 | | Multi-slot class 12 Full PBCCH support Mobile Station Class B Coding Scheme 1 – 4 | |
| Data Rate (max.) | DL 921Kbps, UL 921Kbps | | DL10.2 Mbps, UL5.2 Mbps | |
| Antenna Interface | SMA Female 50ohm | | | |
| Serial Specification | | | | |
| Electrical Standard | RS232 (DB9 Pin 1,2,3,4,5,7,8) or *RS485 (Pin 6,9) | | | |
| Connector type | DB9 Female | | | |
| Baud Rate | Normal Modem: RS232: 1200– 921600bps | Smart Modem: RS232: 300– 460800bps | Normal Modem: RS232: 1200– 921600bps RS485: 1200– 115200bps | Smart Modem: RS232: 300– 460800bps RS485: 300– 115200bps |
| Flow Control | None or Hardware RTS, CTS, DTR, DCD (RS232 only) | | None or Hardware RTS, CTS, DTR, DCD (RS232 only) | |
| Other Interfaces | | | | |
| DI* / AI* | 1 x DI or AI (1.8V 16bits ADC) | | | |
| DO* | 1 x DO open collector, max rating 1A, 48VDC | | | |
| Status LED | 3mm Red | | | |
| Power Supply | | | | |
| Connector Interface | Micro-Fit 3.0- 4pins | | | |
| Supply Voltage | 5-32 VDC | | | |
| Supply Current (Ave) | @5VDC | @32VDC | @5VDC | @32VDC |
| Idle | 55mA | 10mA | 55mA | 10mA |
| Data Transfer (worst case) | 850mA | 150mA | 850mA | 150mA |
| Mechanical | | | | |
| Enclosure Material | Polycarbonate | | | |
| Dimension (Enclosure L x W x H) | 70x53x20mm | | | |
| Weight | 60g | | | |
| Mounting | Clip with Din Rail or screw mounting | | | |
| Environmental | | | | |
| Operating Temperature | -25 to +85 °C | | | |
| Relative Humidity | 90% | | | |
| Water and Dust Proof | IP51 | | | |

* Features are optional.

2.2 Block Diagram

Figure 1 shows a block diagram of a sample configuration that incorporates T61 Smart Modem and typical accessories.

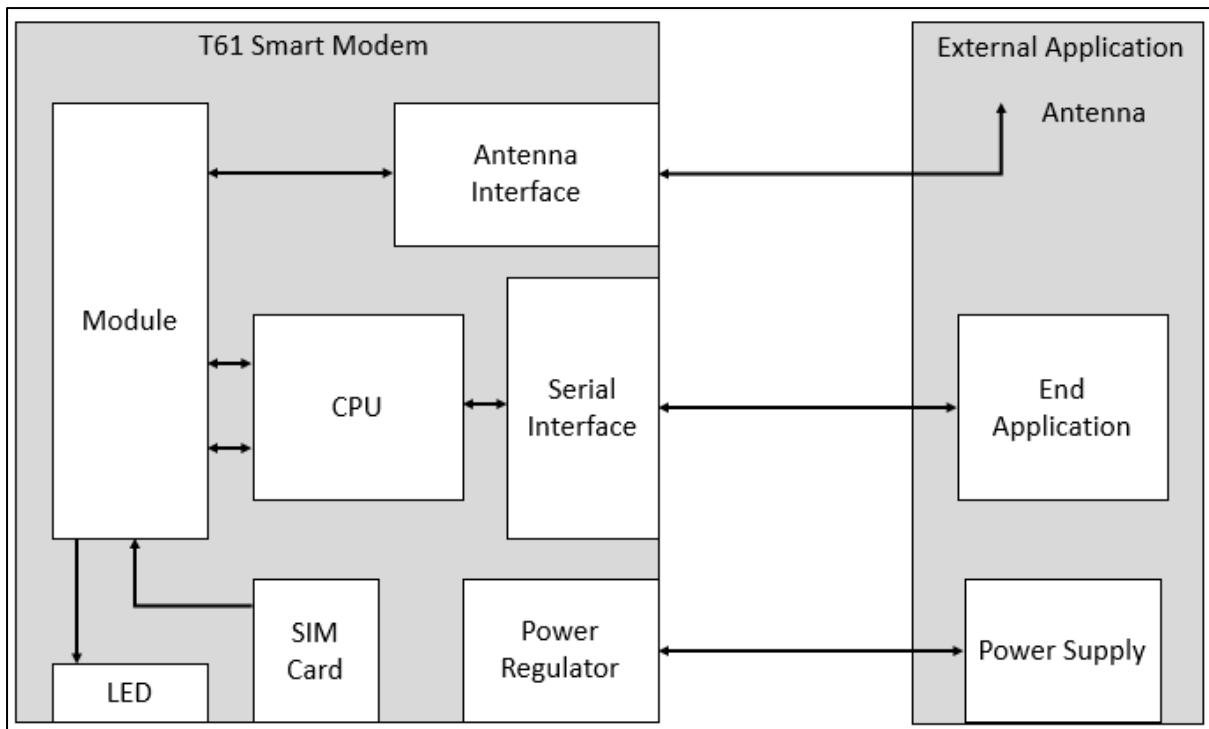

Figure 1: Block Diagram

3 Special Features

In this section, some of the new features of T61 Smart Modem are discussed in detail. This is for better understanding of the device operation in smart modem mode. If your device is utilized in normal modem mode, please skip this section.

3.1 Dual IP Connection

T61 Smart Modem provides two connection channels for easy handling of data and commands. One channel is dedicated for data transfer and the other one process all control commands from command centre or even authorized user mobile devices. This is realized by setting up two internet connections, Data Line Connection (TCP/UDP) and Command Line Connection (TCP) (shown in Figure 2 below).

- **Data Line Connection:** Transparent/User Defined data transfer channel. It is used for obtaining raw data from remote devices.
- **Command Line Connection:** Receive and process control commands. It can be used to obtain device status, like signal strength, device ID, connection status and device current IP etc. This connection is also used for GPRS configuration, and (firmware over-the-air) FOTA when necessary.

These two connections can share a single server IP with different port numbers or they can be connected to two different server IPs. Connections are set up automatically by the device. The idea is to protect the integrity of user data with minimal interference from control commands. In the case where command line connection is not needed, it can be simply disabled. The internet protocol for data line connection can be customized as TCP or UDP but the internet protocol for command line connection is always fixed as TCP.

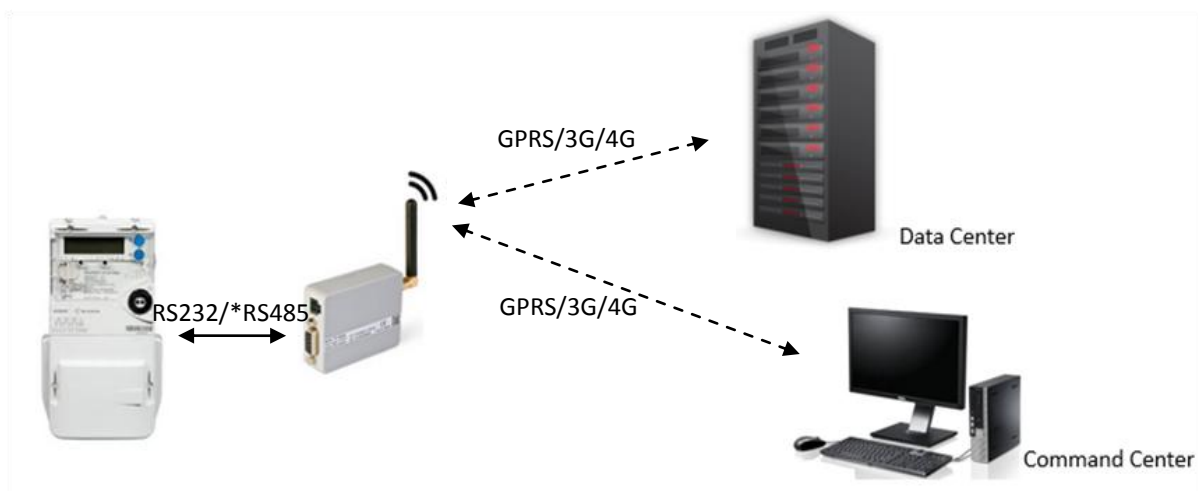

Figure 2: Dual IP Connection

3.2 Self-Recovery

T61 Smart Gateway has built in recovery features to cater connection lost scenario. However these features are only applicable when T61 Smart Gateway is set into smart modem mode and as a TCP Client. Simply speaking, the device will restart itself when the server is no longer accessible. Please pay attention to the following points regarding this recovery features.

- Data Line Connection has higher priority. This setting is to safe guard the integrity of user data communication. Once the device detect the data center is not accessible, it will restart itself and try to reconnect back to the data center. In the meantime, command line connection will break due to the reset.
- Self-recovery will take effect immediatly if connection lost is due to closing Center Manager or losing GSM/GPRS/3G signal. It may take longer time if the connection lost is due to abnormal sever shut down (i.e. connection is not properly closed).

3.3 DDNS IP Update

In order to connect the remote device to data server, IP address of data server is needed. This becomes an issue when IP address is dynamic and changes over time. Dynamic Domain Name Sever IP Update is implemented in T61 Smart Modem to resolve this issue. A domain name is used instead of IP address. This is demonstrated in Figure 3.

```
[ Client Mode info ]  
Server Address: Server1.tmas.com  
Server Port: 9001
```

Figure 3: Domain Name as Server Address

When there is a change in IP address, server will update the new IP to our Domain Name Server so that this new IP will be mapped to the domain name configured inside the device. Therefore, even though the IP address is dynamic, device is always able to connect the correct IP using domain name.

4 Hardware Interface Description

4.1 Overview

T61 Smart Modem provides the following interfaces for power supply, antenna, SIM card and data transfer:

- 4-pin Micro-Fit Power Supply socket
- SMA antenna connector (Female)
- SIM card reader with cover
- DB9 Connector (Female) for RS2323 or *RS485

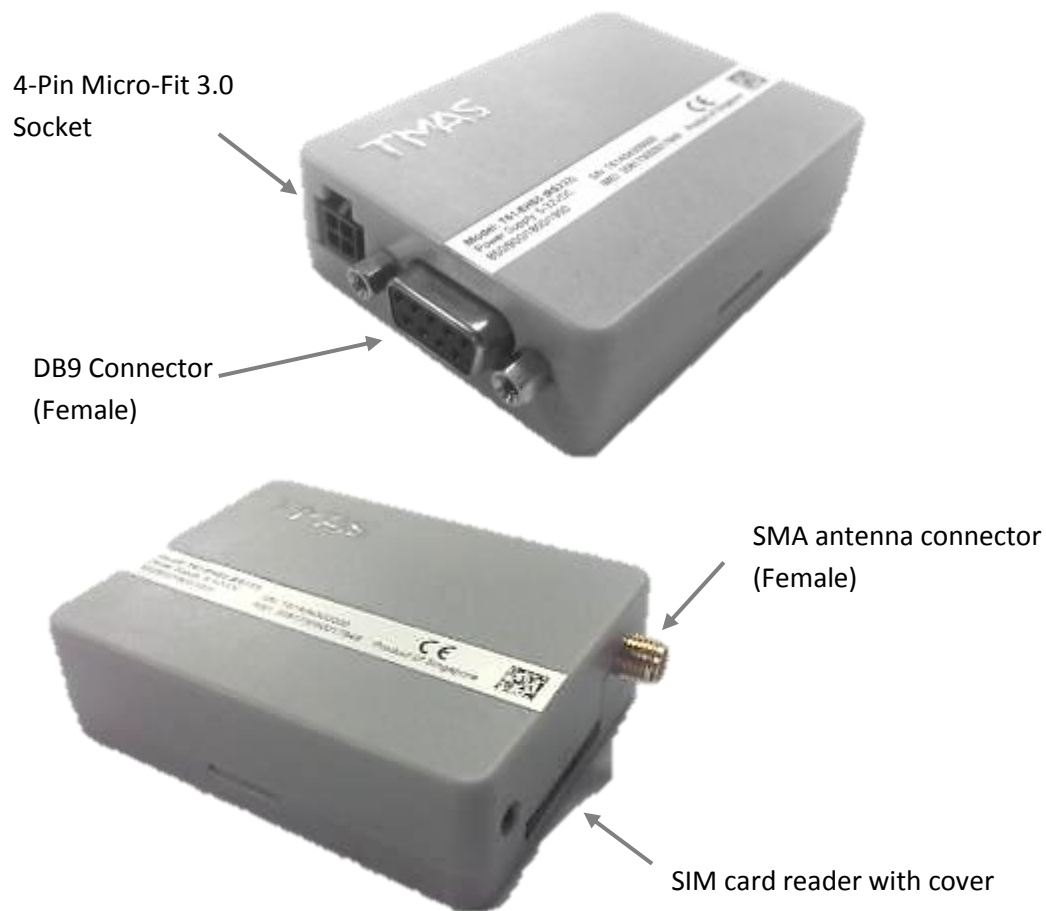

4.2 Interface Variant



Figure 4: DB9 Interface

| Pin | I/O | RS232 | *RS485 |
|-----|-----|-------------|--------|
| | | Description | |
| 1 | O | DCD | - |
| 2 | O | Receive | - |
| 3 | I | Transmit | - |
| 4 | I | DTR | - |
| 5 | - | Ground | - |
| 6 | I/O | - | Data + |
| 7 | I | RTS | - |
| 8 | O | CTS | - |
| 9 | I/O | - | Data - |

4.3 4-Pin Micro-Fit Interface

T61 Smart Modem is powered by a DC with range of 5-32VDC, via 4-pin micro-Fit connector (shown in Figure 5). The other two pins are one digital/analog input and one digital output. Detailed pin assignment please refer to Table below.



Figure 5: 4-Pin Micro Fit Interface

| Pin | Description |
|-----|----------------------------|
| 1 | VCC: 5-32 VDC |
| 2 | Ground |
| 3 | Digital Input/Analog Input |
| 4 | Digital Output |

4.4 SIM Interface



The SIM – with the circuit side facing upwards – is inserted by gently pushing into the SIM card until it snaps hold. After that, close the SIM cover for protection. The process is demonstrated above.

The SIM card cover is designed for tight locking. To open it, please open from the left side of the cover.

To extract out the SIM card, push the SIM card inward to unlock the SIM card.

4.5 Status LED

T61 Smart Modem has one red LED indicating the device and network status. When the device detects no SIM card inserted or no antenna or not yet connected to network, the LED will blink fast at approximately every one second. The detail “ON/OFF” timing of the LED is presented in the following table.

| LED mode | Operating status of T61 |
|--------------------|---|
| Permanently OFF | T61 is not powered on |
| Permanently ON | T61 is in Configuration |
| 30ms ON/470ms OFF | During data transfer |
| 30ms ON/3970ms OFF | Registered to a network. No data transfer |
| 500ms ON/500ms OFF | Limited Network Services/ Network not registered/ (e.g. because no SIM/USIM, no PIN or during network search) |

4.6 Antenna Interface

An external antenna is connected via the T61’s female SMA connector (shown in Figure 6).



Figure 6: Antenna Interface

5 Mechanics, Mounting and Packaging

5.1 Mechanical Dimensions

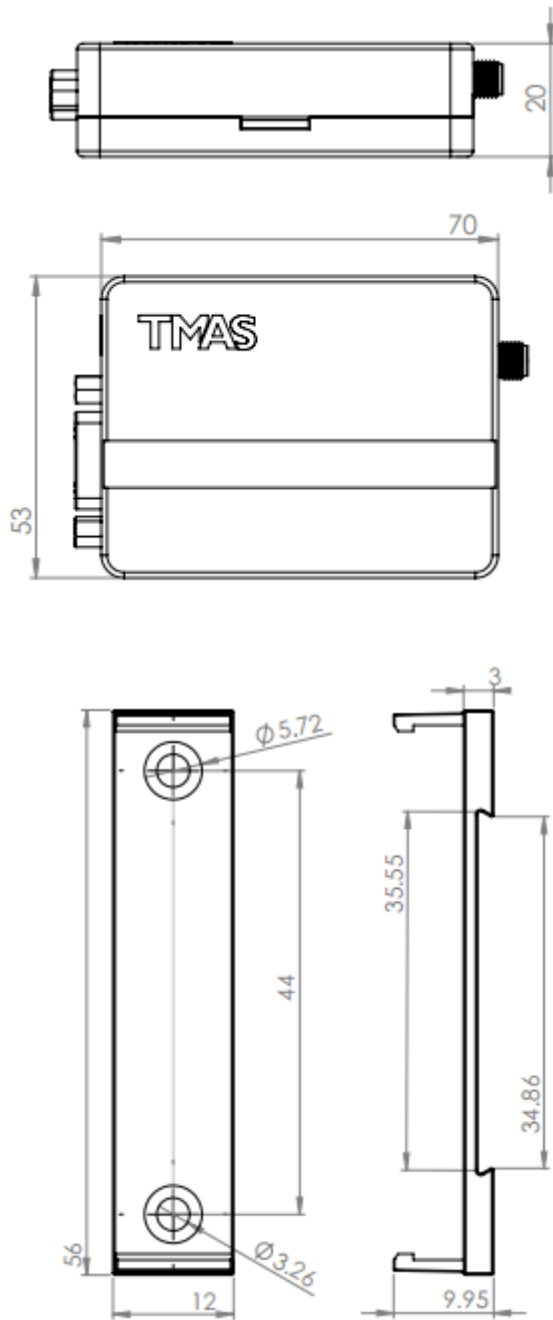

5.2 Mounting T61 Smart Modem

T61 is equipped with a mounting clip as shown in Figure 7.



Figure 7: T61 with mounting clip



To mount the device, first please fix the mounting clip on the wall or a DIN rail and then attach the T61 device to the clip.

5.3 Packaging

T61 Smart Modem is available as a standalone terminal. It can be ordered without any accessories. T61 Smart Modem Kit Set is also available.

T61 Smart Modem Kit Set includes all necessary accessories:

- T61 Smart Modem Terminal
- AC/DC power adapter with 4-pins Micro-Fit plug, DC 12V, 1A
- Female-to-male DB9 modem cable
- Quad-band Antenna (2dBi)
- TMAS Center Manager Software



5.4 Cable connection - T61-EHS5 modem and Landis & Gyr Meter



Part Number: T61-ZMD-01



Cable connection to modem

Cable Connection Layout

| To Landis & Gyr Meter | | To T61-EHS5/ T61-ELS61 | |
|-----------------------|--------|------------------------|--------|
| | | | |
| Pin | Signal | Pin | Signal |
| 1 | - | 8 | CTS |
| 2 | CTS | 2 | RX |
| 3 | RX | 5 | GND |
| 4 | GND | 5 | GND |
| 5 | GND | 3 | TX |
| 6 | TX | | |
| 7 | - | | |
| 8 | VDD | 1 | VDD |
| | | 2 | GND |

6 Get Started

T61 Smart Modem is a plug-and-play device. After simple configuration it will be ready to carry out its mission. This section will guide you step-by-step to setup your device. For a more intuitive setup guide, you can also watch our video guide online (<https://www.youtube.com/watch?v=0YXLVhjDXEA>).

The video guide is also included in the Center Manager Installation CD.

6.1 Box Open

T61 Smart Modem Kit Set will be delivered with all necessary accessories inside.

Before starting the setup, please make sure your SIM card and power socket is ready. Unpack everything from the box and follow the steps below:

Step 1: Open the SIM card cover from left using a sharp pointer.

Step 2: Insert your SIM card into the tray with circuit side facing upwards. Close the SIM cover.

Step 3: Screw the antenna to the SMA connector. Please be gentle, over screwing may cause damage to the device.

Step 4: Off your socket power and plug in the adapter. Connect the square head to the device's power socket.

Now your device is ready to power up.

7 Device Configuration

T61 Smart Modem is robust and comprehensive. Most of its properties are configurable to cater different requirements. In this chapter, all configuration options will be discussed.

There are two ways to configure T61 Smart Modem. One way is using TMAS Center Manager software (Refer to the Center Manager User Guide). The other way is to use serial terminal software. And terminal software will do the job, while HyperTerminal and Hercules are recommended. A configuration menu is embedded inside T61 smart gateway. User can easily configure the device via serial port. In this chapter, we will focus on the serial port configuration method. All screenshots are taken using HyperTerminal.

7.1 Initial Setup

To configure T61 smart gateway, serial terminal software should be configured as followed:

- Baud Rate: 115200bps
- Data Bits: 8
- Parity Bit: None
- Flow Control: None

The factory default operation mode of T61 smart gateway is Normal Modem Mode, switch to Smart Modem Mode before you continue. After powering up the device, you will see the start-up menu shown in Figure 8. This start-up menu includes device mode, firmware version and product serial number.

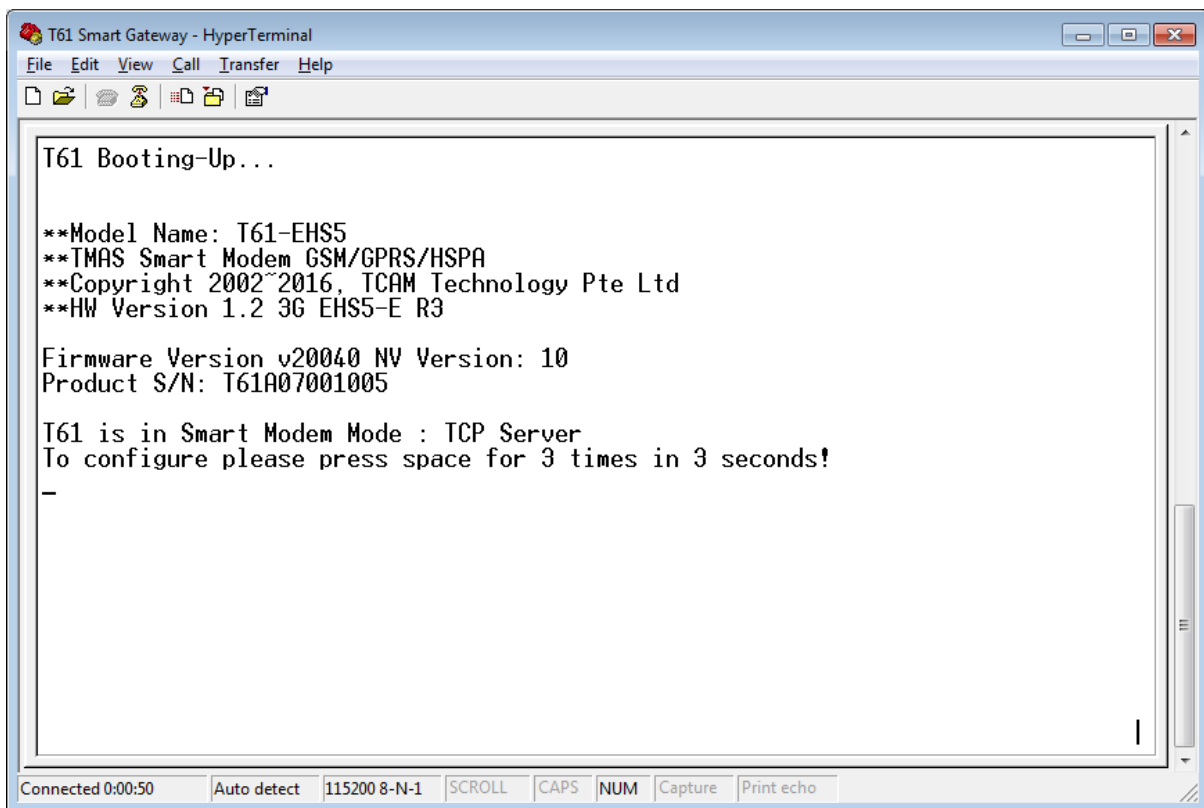

```
T61 Smart Gateway - HyperTerminal
File Edit View Call Transfer Help
T61 Booting-Up...

**Model Name: T61-EHS5
**TMAS Smart Modem GSM/GPRS/HSPA
**Copyright 2002~2016, TCAM Technology Pte Ltd
**HW Version 1.2 3G EHS5-E R3

Firmware Version v20040 NV Version: 10
Product S/N: T61A07001005

T61 is in Smart Modem Mode : TCP Server
To configure please press space for 3 times in 3 seconds!
-

Connected 0:00:50 Auto detect 115200 8-N-1 SCROLL CAPS NUM Capture Print echo
```

Figure 8: Start-up Menu

Following the pop-up message, press space for three times within three seconds to start configuration, otherwise the device will automatically start internet connection. After pressing space for three times, user needs to input the device password (shown in Figure 9). The factory default password for all T61 smart gateway devices is “tcam”, all in small letters. Change of [device password](#) will be covered in later part. T61 smart gateway main configuration menu is shown in Figure 10.

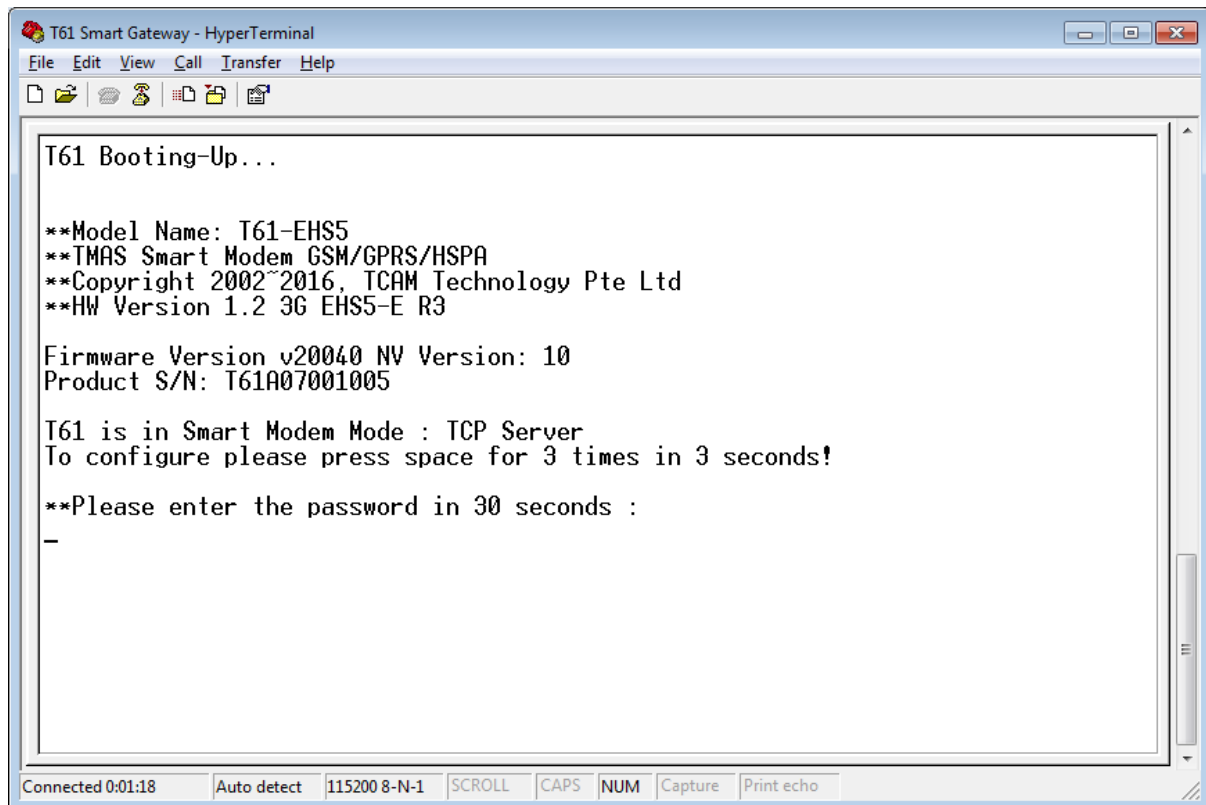

Figure 9: Input Password

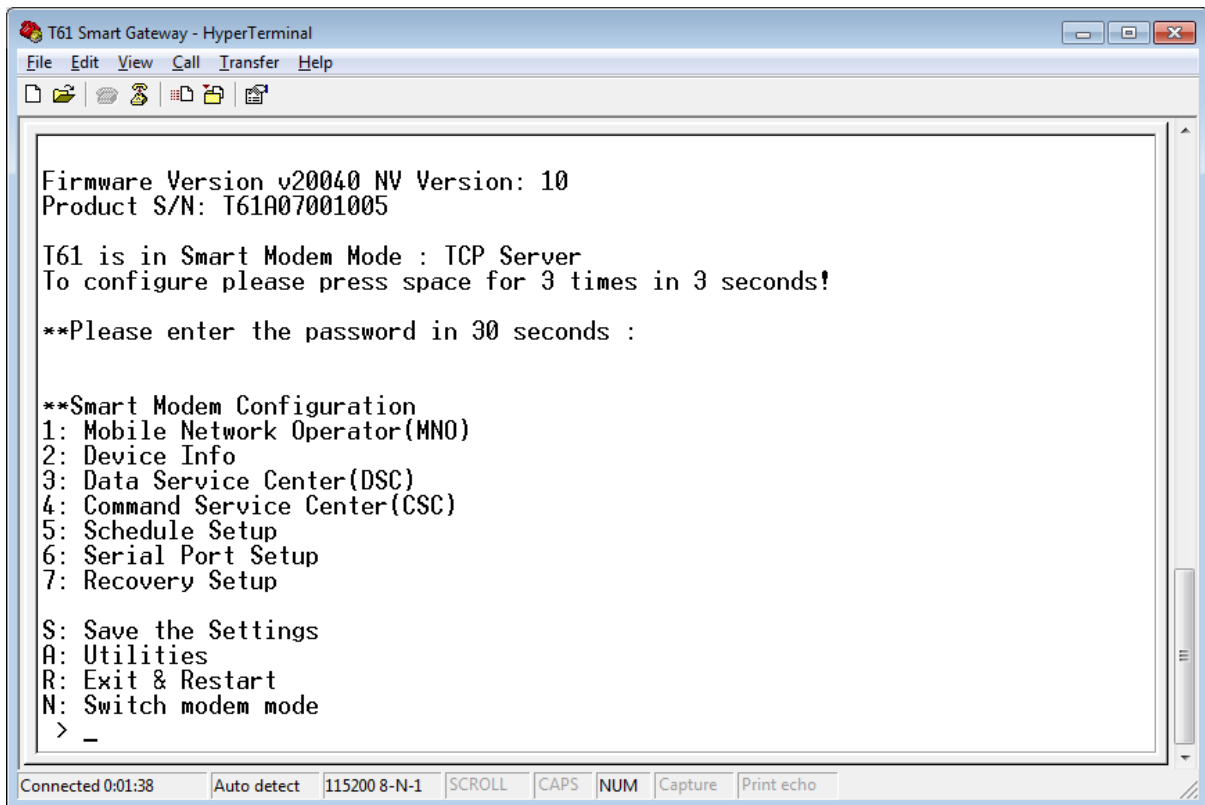
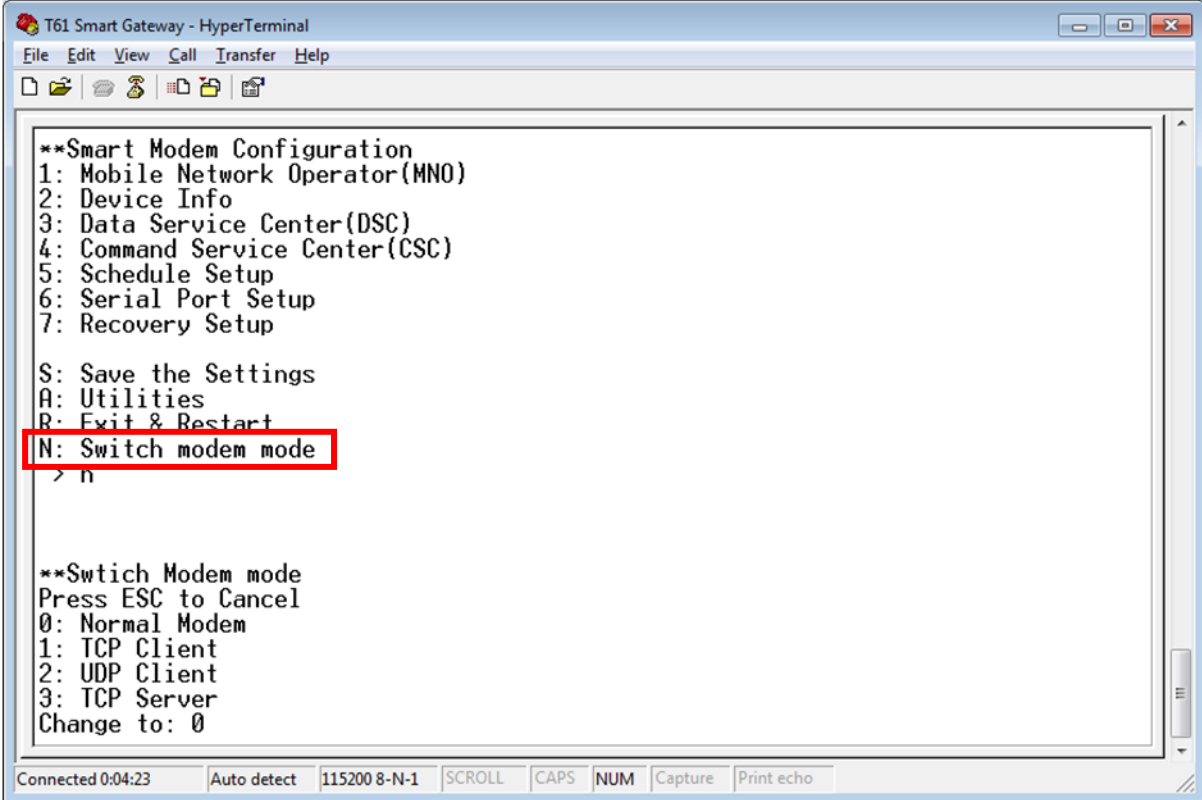

Figure 10: Main T61 Configuration Menu

7.2 Switching Between Smart Modem Mode and Normal Modem Mode

7.2.1 Switch to Normal Modem Mode

If your T61 devices are utilized as normal modem, you need to switch them to Normal Modem Mode. At the main T61 configuration menu, select option “N: Switch Modem Mode” (shown in Figure 11) by pressing “n” or “N” and key in “0” Normal Modem selection and enter.



```
T61 Smart Gateway - HyperTerminal
File Edit View Call Transfer Help
**Smart Modem Configuration
1: Mobile Network Operator(MNO)
2: Device Info
3: Data Service Center(DSC)
4: Command Service Center(CSC)
5: Schedule Setup
6: Serial Port Setup
7: Recovery Setup

S: Save the Settings
A: Utilities
R: Exit & Restart
N: Switch modem mode
> n

**Switich Modem mode
Press ESC to Cancel
0: Normal Modem
1: TCP Client
2: UDP Client
3: TCP Server
Change to: 0

Connected 0:04:23 Auto detect 115200 8-N-1 SCROLL CAPS NUM Capture Print echo
```

Figure 11: Switch to Normal Modem Mode

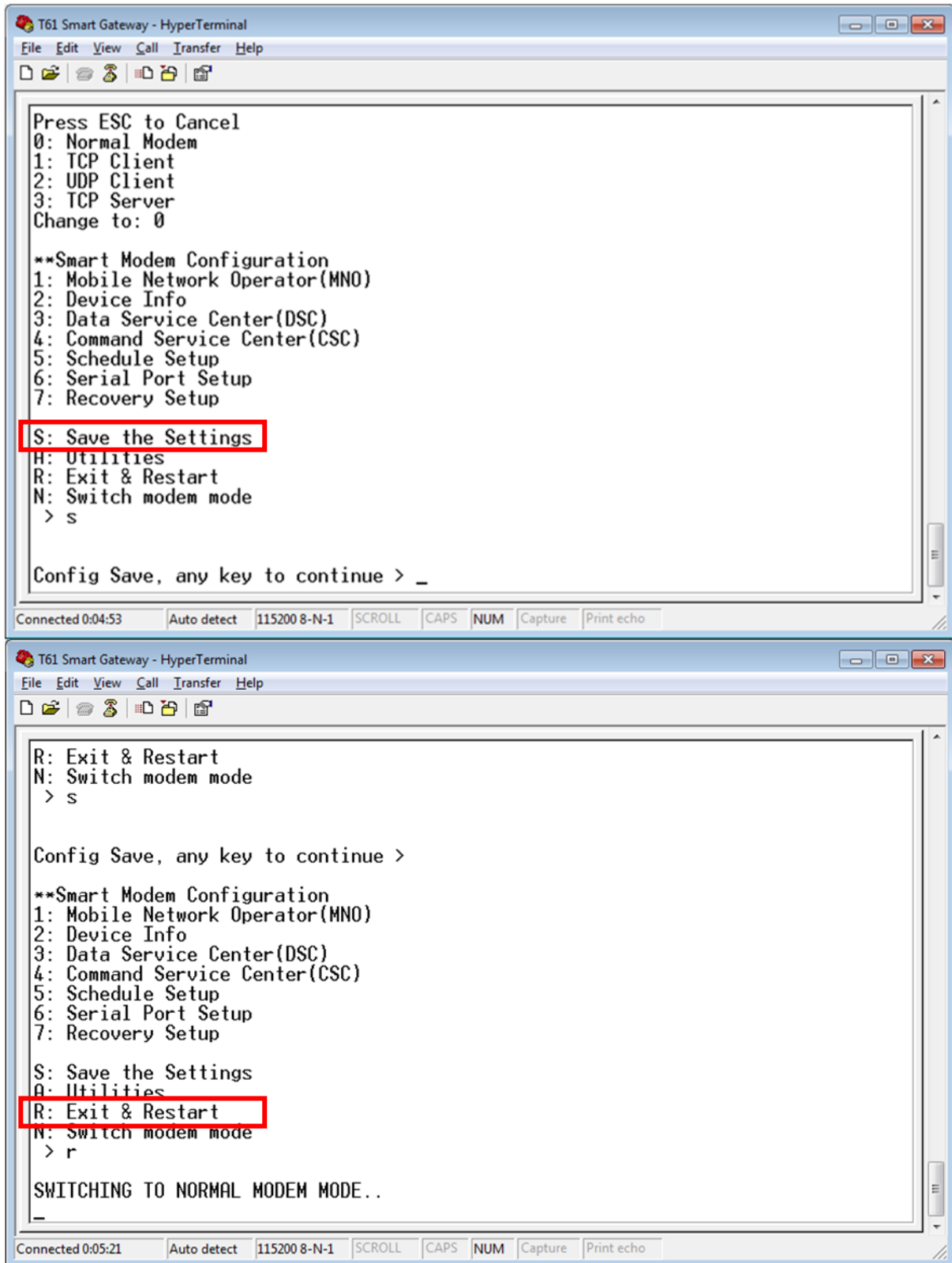
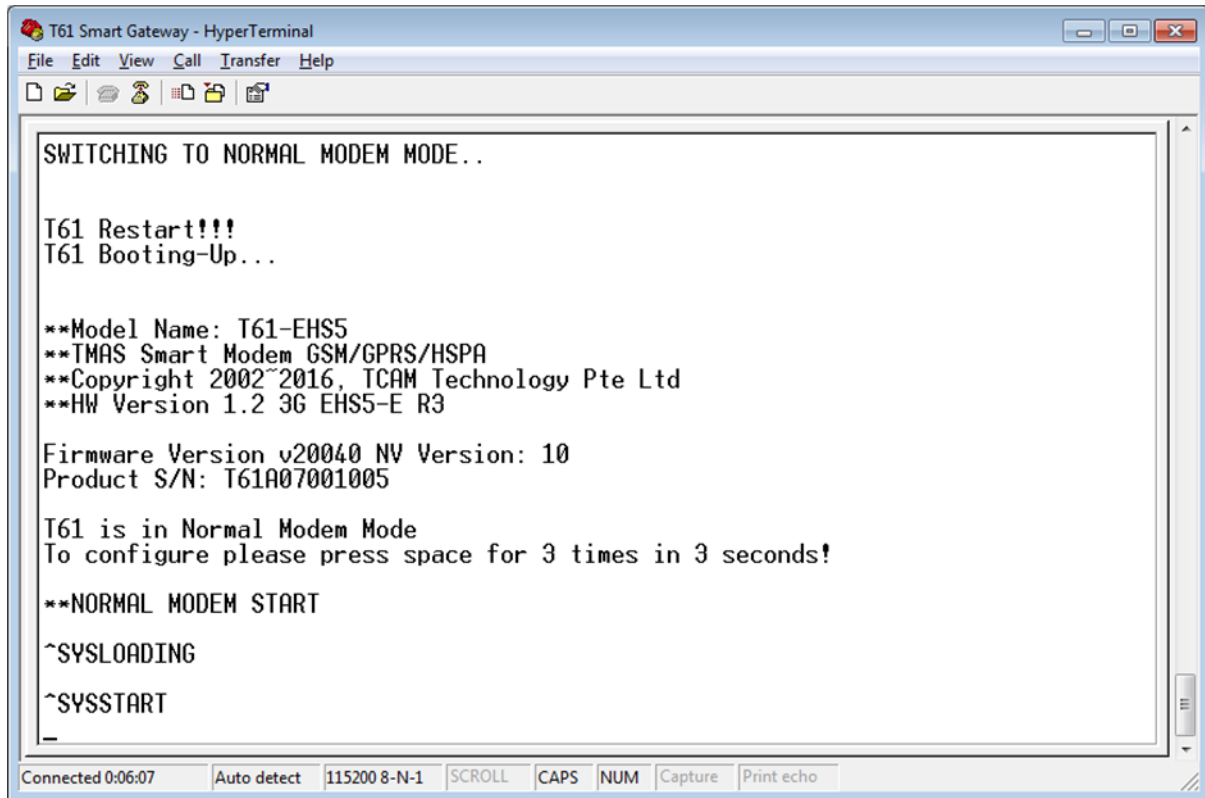

Figure 12: Switching to Normal Modem Mode

Type “S” to save the settings and any key to continue. Type “R” to exit the menu and restart the mode. As shown in Figure 12, after selecting option “N: Switch to Normal Modem Mode”, a message will pop up stating that the device is switching to Normal Modem Mode. The process takes a few seconds. After the switching is finished, your T61 device will restart automatically and start

operating as a normal standard modem (shown in Figure 13). No other configuration is needed for Normal Modem Mode.

Note: After switching to normal modem, the module baud rate will be changed to “AT+IPR=0”. To make changes to adapt to external applications, please use corresponding AT command like “AT+IPR=9600”.



```
T61 Smart Gateway - HyperTerminal
File Edit View Call Transfer Help
SWITCHING TO NORMAL MODEM MODE..

T61 Restart!!!
T61 Booting-Up...

**Model Name: T61-EHS5
**TMS Smart Modem GSM/GPRS/HSPA
**Copyright 2002~2016, TCAM Technology Pte Ltd
**HW Version 1.2 3G EHS5-E R3

Firmware Version v20040 NV Version: 10
Product S/N: T61A07001005

T61 is in Normal Modem Mode
To configure please press space for 3 times in 3 seconds!

**NORMAL MODEM START

^SYSLOADING

^SYSSTART

Connected 0:06:07 Auto detect 115200 8-N-1 SCROLL CAPS NUM Capture Print echo
```

Figure 13: T61 Smart Gateway in Normal Modem Mode.

7.2.2 Switch to Smart Modem Mode

After setting T61 smart gateway to Normal Modem Mode, it is possible to switch it back to Smart Modem Mode easily. The only step is to press space for 3 times upon start-up and enter [device password](#). Repeat the steps for Switch to Normal Modem Mode but key in your choice of modem mode for example “3” TCP Server.

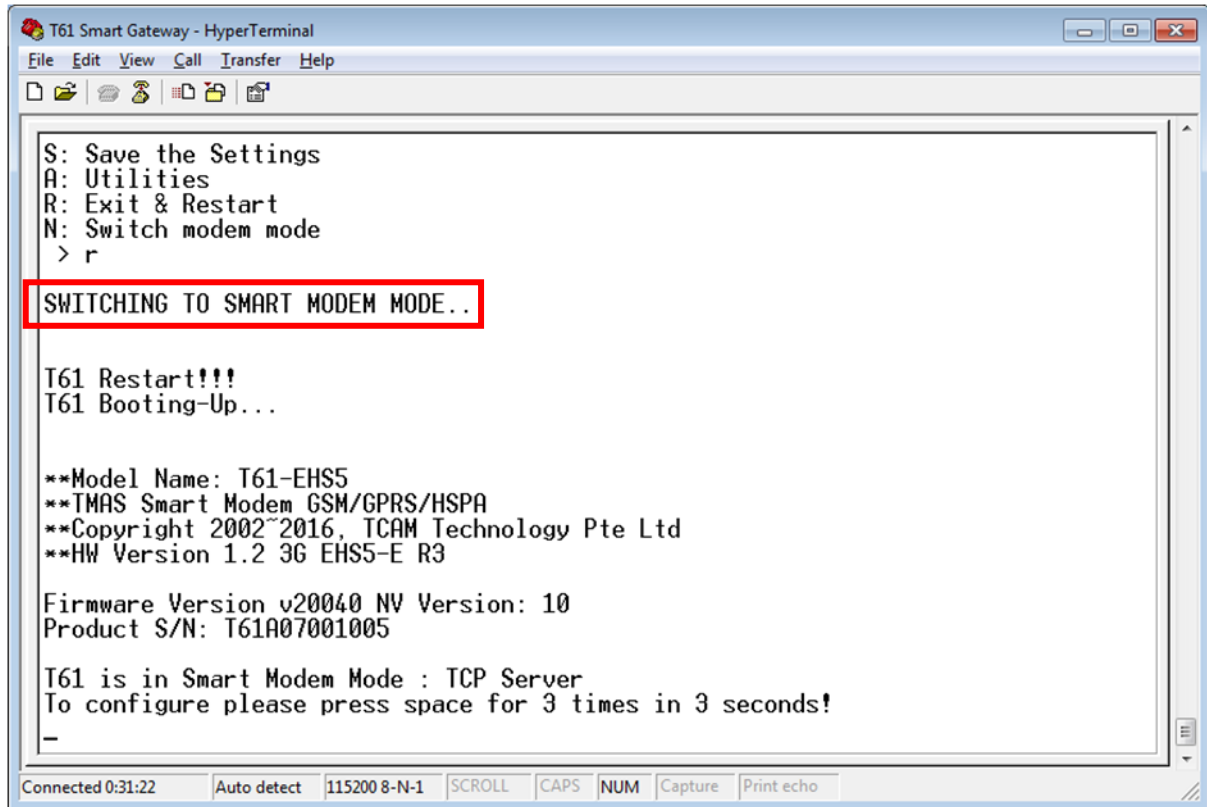

```
T61 Smart Gateway - HyperTerminal
File Edit View Call Transfer Help
S: Save the Settings
A: Utilities
R: Exit & Restart
N: Switch modem mode
> r
SWITCHING TO SMART MODEM MODE..
T61 Restart!!!
T61 Booting-Up...
**Model Name: T61-EHS5
**TMS Smart Modem GSM/GPRS/HSPA
**Copyright 2002~2016, TCAM Technology Pte Ltd
**HW Version 1.2 3G EHS5-E R3
Firmware Version v20040 NV Version: 10
Product S/N: T61A07001005
T61 is in Smart Modem Mode : TCP Server
To configure please press space for 3 times in 3 seconds!
-
Connected 0:31:22 Auto detect 115200 8-N-1 SCROLL CAPS NUM Capture Print echo
```

Figure 14: Switching to Smart Modem Mode

Figure 14 shows the message prompted when the device is switching to Smart Modem Mode. The entire process takes few seconds.

Please take note that, it is recommended to re-configure all necessary settings in Smart Modem Mode after switching modem mode.

7.3 Smart Modem Configuration

T61 smart gateway is flexible. Most of its parameters are configurable to suit various requirements. The configuration procedure is simple and intuitive. Devices only need to configure once upon the first usage. Afterwards, the device will memorize all settings in its non-volatile memory.

The following section will start with generation guidelines for configuration using serial terminal software, such as general keys, saving procedure, reboot options and etc. Then it will focus on the major settings including network operator settings, serial interface settings, data center and command center settings and etc.

7.3.1 General Guidelines for Smart Modem Configuration

The following is some general guidelines applicable to most of the menu settings.

7.3.1.1 View Settings

User is able to view all setting parameters in a list for each section. For example, if you intend to check all settings under “Mobile Network Operator (MNO)” section, you can go into that menu and the respective settings value are shown in square bracket. This is demonstrated in Figure 15.

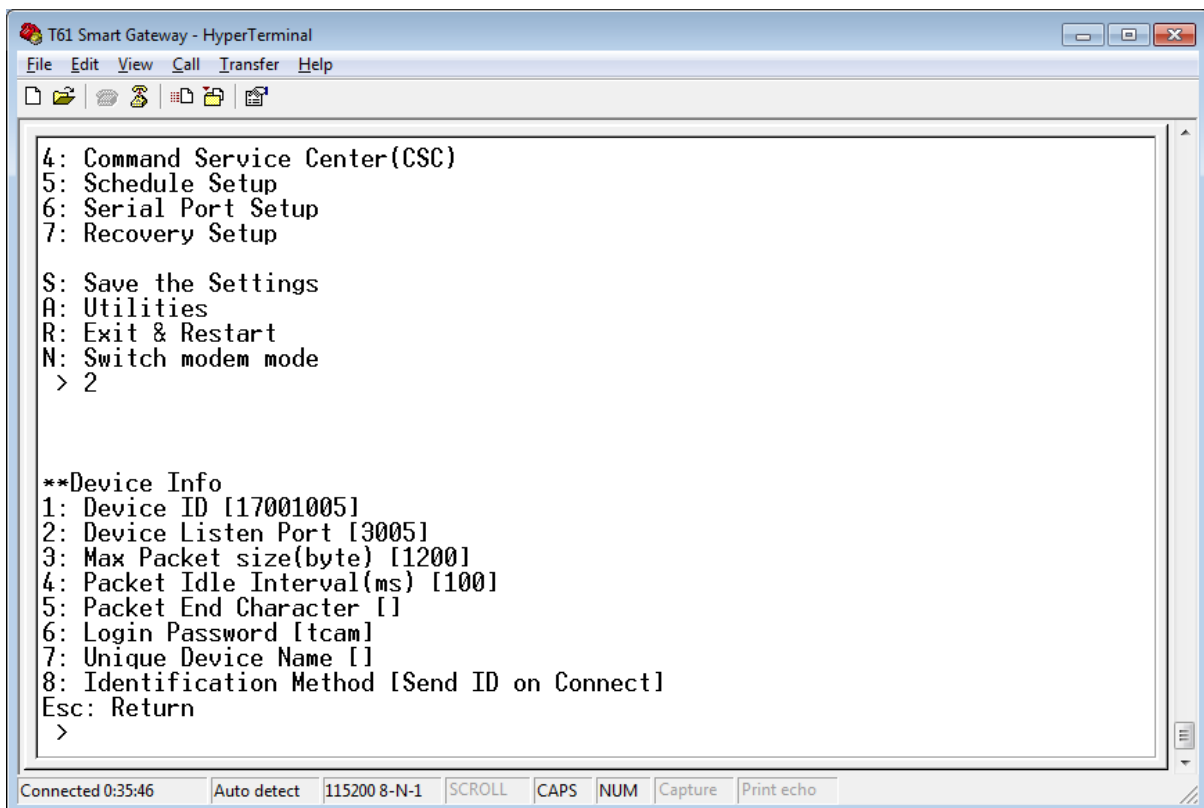

Figure 15: Display all settings

7.3.1.2 Return to parent menu

When modification is done, user shall return to the parent menu by pressing “ESC”.

7.3.1.3 Save the Settings

After modification, please select “S: Save the Settings” (shown in Figure 16). Updated settings only take effects after reboot.

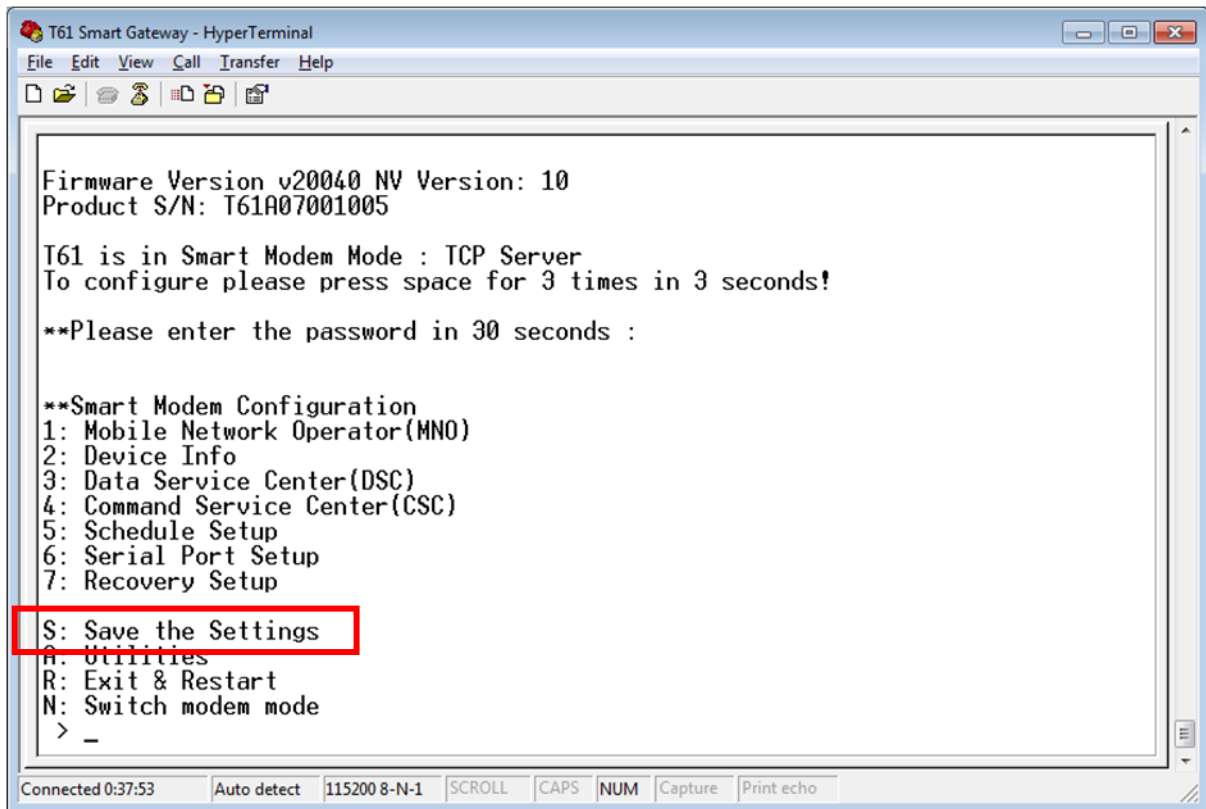

Figure 16: Save the Settings

7.3.1.4 Reboot T61 Smart Modem

There are three ways to reboot T61 device.

- Choose the Reboot Option from the main T61 Configuration menu.
- Send “T++” via the COM port. This is only applicable when T61 device is in configuration mode or modem mode.
- Power reset the T61.

Notes: After changing the settings, please press ENTER to confirm your inputs. Before restarting the device, please SAVE your modified settings, otherwise the changes will not take effect.

7.3.2 Mobile Network Operator (MNO)

This section is more related to the SIM card network operator. Some settings can be very crucial for T61 Smart Modem to function properly, like Access Point Name (APN).

7.3.2.1 GPRS Dial-Up Number

This parameter is not utilized by T61 device. It is a reference for user when the device is used as standard dial-up modem.

String

*99***1# (Default) This is the default dial-up number for standard modem

7.3.2.2 PPP User Name & PPP Password

These two parameters are optional and may be required by certain SIM card for internet connection. The factory default values for these two parameters are blank.

7.3.2.3 Access Point Name (APN)

This parameter is crucial to most of network operators. SIM cards need this parameter to be in place in order to access the internet.

String

internet This parameter is mandatory for internet access

7.3.2.4 SIM PIN

If the SIM card is PIN protected, the module will not able to access the SIM card functions without a correct PIN number. Please contact the mobile network operator to check whether your SIM card is PIN protected.

String

Default setting is blank

7.3.3 T61 Device Information

This section includes basic device settings such as configuration password, local listen port and so on. It also defines how the device should packetize the incoming data.

7.3.3.1 Device ID

This parameter displays the device ID. It is only for reference and cannot be configured.

Number

1xxxxxxx It is 8 digits number starting with "1".

7.3.3.2 Listen Port

This parameter is utilized when T61 Smart Modem is set as a TCP server. It is the device's local listening port for remote clients.

Integer

1-65535 Local listening port number for internet sever setup

7.3.3.3 Packetization

There are three parameters defining the way T61 smart gateway packetizing the incoming data. The benefit of packetizing data is to make sure that data received and sent out is wrapped within one single packet. It becomes handy when end applications can only digest incoming data within one single packet. The drawback of packetizing data is that it slows down the data transfer rate.

Max Packet Size (byte)

Integer

0-1200(default)-1450 Maximum number of bytes per packet.

Packet Idle Interval (ms)

Integer

0 Disable packetization and enable transparent mode
 1-100 (Default)-65535 Inter-packet delay in milliseconds.

Packet End Character

String

Default setting is blank
 Packet ending character. This string is a display of the hex value of Packet End Character, i.e. the Packet End Character is 0x0D.

To configure the Data Line as a transparent communication channel and disable the packetization, please change Packet Idle Interval to 0. As long as the Packet Idle Interval setting is not 0, all incoming data will be packetized using an algorithm described below.

```

if(Data Length>=Max Package Size){
    Send out all incoming data;
}else if(found Packet End Character){
    Send out all incoming data;
}else{
    if(Packet Idle Interval time out){
        Send out all incoming data;
    }
}

```

7.3.3.4 Login Password

This parameter defines the password required to enter T61 Configuration menus. The factory default password is “tcam”, all in small letters. User can change this password upon first login or leave as default.

String

tcam This is the default password, user can change to another one with maximum length of 8 bytes

7.3.3.5 Unique Device Name

This parameter is the same as the device name recorded in Center Manager if it is in use. It can be configured to user defined device name or different serial number assigned by customers for applications. This device name will be used for SMS alert.

String

Device Name A name string up to 18 characters.

7.3.4 Data Service Center (DSC)

Data Service Center refers to the server where Data Line of T61 Smart Modem will connect to. All parameters related to Data Line are grouped under this section.

7.3.4.1 Data Line Protocol

This parameter defines T61's internet protocol and whether the device is a client or server.

| Index | |
|-------|------------|
| 1 | TCP Client |
| 2 | UDP Client |
| 3 | TCP Server |

7.3.4.2 Primary Server Address

This parameter refers to the primary Data Center server address. It can be in the form of IP address or domain name, e.g. 119.65.111.125 or DataCenter.server.com. If this server address is configured as a domain name, DNS Server Address must be defined with a valid IP address. For the situation in which this server is not available, the device will automatically connect to its backup server.

| String | |
|----------------------|------------------------------------|
| xxx.xxx.xxx.xxx | Server Address in IP form |
| DC.server.com (e.g.) | Server Address in Domain Name form |

7.3.4.3 Backup Server Address

In the case which device is not able to connect to [primary server](#), it will start trying the backup server defined in this parameter. It also can be in form of IP address for domain name. If this server address is configured as a domain name, DNS Server Address must be defined with a valid IP address. If T61 device not able to connect to this backup server, it will restart automatically and retry from the primary server again.

| String | |
|----------------------|------------------------------------|
| xxx.xxx.xxx.xxx | Server Address in IP form |
| DC.server.com (e.g.) | Server Address in Domain Name form |

7.3.4.4 Server Port

This parameter sets the Data Center listening port. Both primary server and backup server will be using this port number.

| Integer | |
|---------|--|
| 1-65535 | Server listening port number for internet connection |

7.3.4.5 Center Phone Number

T61 smart gateway in Smart Modem Mode is able to answer data call and execute commands from SMS. By factory default, this parameter is set to "0". If it is set to "0", T61 will answer data call and execute SMS commands from any number. If this parameter is set to a number other than "0", the device will only answer data call and execute SMS commands from this particular phone number. Data call or SMS commands or other random SMS from other numbers will be ignored.

String

| | |
|----------------|---|
| 0 | Device will response to data call or SMS from any number |
| 9876541 (e.g.) | Phone number in the string form up to 19 characters. Country or area codes are optional |

7.3.4.6 DNS Server Address

This parameter is important if you are using domain names for Server Address or Backup Server Address. The factory default value points to the DDNS server host by TCAM Technology Pte Ltd. Modifying this parameter may affect the dynamic IP mapping mechanism.

String

| | |
|-----------------|---------------------------|
| xxx.xxx.xxx.xxx | Server Address in IP form |
|-----------------|---------------------------|

7.3.4.7 GPRS Reliable Test Interval

This parameter defines the period of T61's periodic self-check mechanism when it is set as a TCP server. This periodic self-check feature is to ensure that T61 device is always connected to the network and available for incoming client connection.

Integer

| | |
|---------|--|
| 0 | Disable this feature |
| 1-65535 | Self-check interval in unit of minutes |

7.3.5 Command Service Center (CSC)

Command Service Center is where Command Line connects to. It can be enabled or disable by configuring the Server IP Address.

7.3.5.1 Server IP Address

This parameter defines the IP address of the Command Service Center. If it is set to empty, Command Line Connection will be disabled.

String

| | |
|----------------------|---|
| xxx.xxx.xxx.xxx | Server Address in IP form |
| DC.server.com (e.g.) | Server Address in Domain Name form |
| | Change it to empty to disable Command Line Connection |

7.3.5.2 Server Port Number

This parameter defines the port number of the Command Service Center. It cannot be set to empty or 0 otherwise the device will encounter a problem during connection setup.

Integer

| | |
|---------|--|
| 1-65535 | Server listening port number for internet connection. This is mandatory. |
|---------|--|

7.3.5.3 Heartbeat Interval

This parameter refers to the time interval in seconds for device to send a heartbeat via Command Line to the Command Service Center. The heartbeat will report the device current status including signal strength, IP address and whether the data line is still online. The Command Service Center will judge whether the remote device is still functioning by observing its heartbeat. This parameter is not applicable if Command Service Center option is configured as disabled.

Integer

| | |
|----------|--|
| 0 | Disable this feature (Not recommended) |
| 10-65535 | Heartbeat interval in the unit of a second |

7.3.6 Serial Port Setup

Serial interface settings are also very important for external applications. T61 smart gateway in Smart Modem Mode can accept a wild range of baud rates.

7.3.6.1 Baud Rate

Currently autobauding is not supported.

| <i>Index</i> | |
|--------------|--------|
| 0 | 300 |
| 1 | 1200 |
| 2 | 2400 |
| 3 | 4800 |
| 4 | 9600 |
| 5 | 19200 |
| 6 | 38400 |
| 7 | 57600 |
| 8 | 115200 |
| 9 | 230400 |
| A | 460800 |

7.3.6.2 Data Bits

T61 smart gateway in Smart Modem Mode is able to accept 7 data bits with odd/even/mark/none parity bit. It also supports 8 data bits without any parity bit. For the current firmware version, if the device is set to 8 data bits, the parity bit must be set to none.

| <i>Index</i> | |
|--------------|-------------|
| 7 | 7 Data bits |
| 8 | 8 Data bits |

7.3.6.3 Parity Bit

Four parity bit options are available:

| <i>Index</i> | |
|--------------|-----------------|
| 0 | None parity bit |
| 1 | Odd |
| 2 | Even |
| 3 | Mark |

7.3.6.4 Stop Bit

T61 smart gateway in Smart Modem Mode supports 1 or 2 stop bits.

| <i>Index</i> | |
|--------------|-------------|
| 1 | 1 stop bit |
| 2 | 2 stop bits |

7.3.6.5 Flow Control

T61 in Smart Modem Mode supports CTS/RTS hardware flow control. Change the setting to '0' to disable flow control; change the setting to '1' to enable it. For high speed data communication, especially for 3G module T61-EHS5, flow control is highly recommended.

Index

| | |
|---|--|
| 0 | None, to disable flow control feature |
| 1 | Enable CTS/RTS hardware flow control feature |

7.3.7 Recovery Setup

This section includes parameters related to recovery and redundancy mechanisms. User is able to define when to activate the data line connection, how to recover from data line connection lost and how frequent the device resets itself to avoid malfunctioning.

7.3.7.1 Activation Option

This parameter defines the condition for T61 Smart Modem to start its data line connection. If this parameter is not 0, the device will become idle after powering up and wait for the activation condition to be satisfied.

Index

| | |
|---|--|
| 0 | Automatic – Start connection automatically upon power-up |
| 1 | Wait for SMS – Start connection after receiving a SMS from the Center Phone Number . Please contact TCAM Technology if you want this feature to be enabled. |
| 2 | Wait for Call – Start connection after receiving a Call from the Center Phone Number . Please contact TCAM Technology if you want this feature to be enabled. |
| 3 | Wait for Control SMS – Start connection after receiving a predefined SMS. Please contact TCAM Technology if you want this feature to be enabled. |

7.3.7.2 Recovery Option

This parameter defines how T61 device should restart the connection when there is connection lost.

Index

| | |
|---|---|
| 0 | Constant Retry – T61 device will keep retrying to connect to Data Service Center without any waiting time. |
| 1 | Gradually Retry – T61 device keep retrying to connect to Data Service Center after a waiting interval. This waiting interval will increase exponentially according to the number times device resets. |
| 2 | Wait for SMS – Upon connection lost, T61 device will retry its connection to data center for three times. If the connection is still failed, it will become idle and be waiting for a SMS from the Center Phone Number to restart its connection. Please contact TCAM Technology if you want this feature to be enabled. |
| 3 | Wait for Call – Upon connection lost, T61 device will retry its connection to data center for three times. If the connection is still failed, it will become idle and be waiting for a Call from the Center Phone Number to restart its connection. Please contact TCAM Technology if you want this feature to be enabled. |

7.3.7.3 IP Address Report

If this feature is enabled and the device will update its latest IP when it is available via either SMS or DDNS update.

Boolean

| | |
|---|---|
| 0 | Disable IP report function |
| 1 | Enable SMS report function. When device obtains a new IP it will send a SMS to the Center Phone Number if it is not "0". |
| 2 | Enable IP DDNS update. When device obtains a new IP it will update its IP to a DDNS server to update its domain name, T61AXXXXXXXX.tmas.com using http protocol. Please contact TCAM Technology if you want this feature to be enabled. |

7.3.7.4 DDNS Server IP

This parameter defines the Dynamic Domain Name Server IP. T61 device will update its new IP address to its DDNS host at this IP.

String

| | |
|-----------------|---------------------------|
| xxx.xxx.xxx.xxx | Server Address in IP form |
|-----------------|---------------------------|

7.3.7.5 User Phone Number

This parameter records the user who will receive alarm alerts. If it is left empty, no alert SMS will be sent out.

String

| | |
|----------------|---|
| 9876541 (e.g.) | Phone number in the string form up to 19 characters. Country or area codes are optional |
|----------------|---|

7.3.7.6 Long Life Reset Interval (hr)

This parameter defines how frequent T61 device resets itself to avoid any malfunctioning.

Integer

| | |
|---------|--|
| 0 | Disable this reset mechanism (not recommended) |
| 1-65535 | Enable long life reset mechanism with specified interval in hours. |

7.3.8 I/O Setup (Optional Feature)

This section defines the working mode of the digital input or analog input and digital output pin available at the 4-pin micro-fit interface. If T61 is programmed into smart modem mode, user is able to utilize the input and output functions with proper configuration. These functions are not available when T61 is programmed as normal modem. In general, user is able utilize an input as real-time analog reading port or an alarm trigger input. The digital output of T61 can be control remotely by SMS or command from SMS. This open collector output is capable of driving a circuit with maximum rating of 1A and 48V. When the digital output is triggered, it will connect the digital output pin to the ground.

7.3.8.1 AI Monitor Setting

This parameter configures the analog input reading feature.

Index

| | |
|---|---|
| 0 | Disable analog input monitoring |
| 1 | Real-time Reading. T61 will read the analog input periodically according to the sampling rate and send back the data via data line. |
| 2 | Data Logging (Not available) |

7.3.8.2 AI Report Interval

This parameter is related to the analog input data logging feature. Currently it is not relevant.

Index

| | |
|---|-------------|
| 0 | On Schedule |
| 1 | Hourly |
| 2 | Daily |
| 3 | Weekly |

7.3.8.3 Input Sampling Rate

This parameter defines how frequent the input pin is read. This is only relevant to analog input reading. Digital input monitoring is real-time.

Index

| | |
|---|------------|
| 0 | 10 seconds |
| 1 | 1 minute |
| 2 | 10 minutes |
| 3 | 1 hour |

7.3.8.4 Input Alarm Setting

This parameter determines the alarm trigger events.

Index

| | |
|---|--|
| 0 | Disable |
| 1 | Analog reading is high. Alarm will trigger when analog reading is higher than the high limit . |
| 2 | Analog reading is low. Alarm will trigger when analog reading is lower than the low limit . |
| 3 | Analog reading is either high or low. |
| 4 | Digital input is high. Input will be set as a digital input and it will send alarm message when it is connected to 1.5V. |
| 5 | Digital input is low. Input will be set as a digital input and it will send alarm message when it is short to ground. |

7.3.8.5 Alarm Options

This parameter defines how alarm messages are sent report to user or command center.

Index

| | |
|---|--|
| 0 | SMS alert to user |
| 1 | GPRS alarm report to command center |
| 2 | Activate both of above when alarm is triggered |

7.3.8.6 Input Sensitivity (sec)

Integer

1-255 Number of seconds for the input to confirm the reading. E.g. the input is confirmed to be high only when it is high for at least 2 seconds (when input sensitivity is configured to 2 seconds).

7.3.8.7 AI Alarm Low Limit (%)

integer

0-50 Set the percentage of the full scale to be the analog lower limit. E.g. if the analog input is connected to a voltage output with full scale of 1.8V and the AI Alarm Low Limit is configured to be 30%, the alarm will be triggered when the input voltage is lower than $0.3 \times 1.8 = 0.54V$.

7.3.8.8 AI Alarm High Limit (%)

integer

51-100 Set the percentage of the full scale to be the analog higher limit.

7.3.8.9 Output Settings

Index

| | |
|---|--|
| 0 | Disable |
| 1 | Input Trigger. The digital output pin will be short to ground when the input detects a critical condition. |
| 2 | Remote Control. User is able to control the output pin remotely. |
| 3 | Both |

7.3.8.10 Output Duration (sec)

integer

1-255 Set how long (in seconds) the digital output will be on when it is triggered by input, i.e. when Output Settings is configured to be Input Trigger or Both and the output is triggered by input. If the output is triggered by remote control (SMS or Command), it will be always on until further instruction from the remote.

7.3.9 Utilities

T61 Smart Modem provides some basic and handy utility functions for users.

Options

| | |
|---|---|
| 1 | Load Default Setting – This is to load the factory default settings back to the device. |
| 5 | Recover Smart Modem Baud Rate – This is a backup recovery option for the situations in which CPU can no longer talk to module. It will set module baud rate to be 460800bps. |

7.4 Default Settings

The following table shows the factory default settings of T61 smart gateway. Parameters without any value mean that they are set to blank.

| Parameter | Factory Default Value |
|-------------------------------|-----------------------|
| GPRS Dial-Up Number | *99***1# |
| PPP User Name | |
| PPP Password | |
| Access Point Name | internet |
| SIM PIN | |
| Device ID | 1xxxxxxx |
| Listen Port | 3005 |
| Max Packet Size (byte) | 1200 |
| Packet Idle Interval (ms) | 100 |
| Packet Last Character | |
| Login Password | tcam |
| Data Line Protocol | 3 |
| Primary Server Address | |
| Backup Server Address | |
| Data Server Port | 3007 |
| Center Phone Number | 0 |
| DNS Server Address | |
| GPRS Reliable Test Interval | 180 |
| Command Server IP address | 0.0.0.0 |
| Command Server Port Number | 3006 |
| Heartbeat Interval (s) | 120 |
| Module ON/OFF when IDLE | 0 |
| Device Time Zone | +08 |
| Device Connection Time | 100000 |
| Connection Interval (min) | 60 |
| Baud Rate | 8 |
| Data Bits | 8 |
| Parity Bit | 0 |
| Stop Bit | 1 |
| Flow Control | 0 |
| Activation Option | 0 |
| Recovery Option | 0 |
| IP Address SMS Report | 0 |
| Long Life Reset Interval (hr) | 24 |

7.5 SMS Functions

This section lists SMS commands applicable for T61 Smart Gateways. By sending the following SMS commands from a [register user mobile phone](#), the device is able to respond accordingly.

| SMS Format | Description |
|---------------------------------|--|
| T++ | Reset the device. |
| TIP:[<IP>:<port>][:<IP>:<port>] | Configure the IP and Port of Data Line Connection. E.g. SMS: TIP:115.166.155.166:700 to the device will change data center address to 115.166.155.166 and port number to 700. Device will reboot automatically. If only to configure command center address, SMS format will be "TIP::115.166.155.166:800". Please contact TCAM Technology if you want this feature to be enabled. |
| TON | Turn on (1.8V) Digital Output PIN. Please contact TCAM Technology if you want this feature to be enabled. |
| TOFF | Turn off (0V) Digital Output PIN. Please contact TCAM Technology if you want this feature to be enabled. |

8 Migration from TMA-M37i, TMA-M55i and TMN-51T

In this chapter, T61 Smart Modem will be compared with its predecessor TMN-51T for smart modem operation and TMA-MC37i or TMA-MC55i for normal modem operation.

8.1 Normal Modem Mode

Only some special and common AT Commands comparison are listed in the below table. For more details, please refer the respective AT Command Guides and release notes.

| Features | T61-EHS5/ T61-ELS61 | T61-BGS2 | MC37i/ MC55i |
|-----------------------|---|------------------------------|-----------------|
| AT+IPR=0 | Not Support | Not Support | Support |
| AT+IPR=<num> | Support | Support | Support |
| Baud Rate | Up to 460800 | Up to 230400 | Up to 230400 |
| AT\Q | Only Support AT\Q0 and AT\Q3 | Only Support AT\Q0 and AT\Q3 | Support All |
| AT&S | Not Support | Not Support | Support |
| AT&C | Not Support | Support | Support |
| LED Control | AT^SLED | AT^SSYNC | AT^SSYNC |
| AT+CMGS Send SMS | AT+CMGS=<str> only e.g. AT+CMGS= "98765432" | AT+CMGS=<num> | AT+CMGS=<num> |
| AT+CMGD Delete SMS | AT+CMGD=<index>[,<delflag>] Can delete all message | AT+CMGD=<index> | AT+CMGD=<index> |

8.2 Smart Modem

In this section T61 Smart Modem is compared with TMN-51T in terms of functionalities and operational features. The main focus is the differences.

| Features | T61-EHS5/ T61-ELS61 | TMN-51T |
|---------------------------|--|-------------------|
| Transparent Data Transfer | Support | Not Support |
| Data Packetization | Support | Support |
| Connection | Dual-IP Connection, Data Line and Command Line are separated | Single Connection |
| Baud Rate | Up to 460800bps | Up to 115200bps |
| Schedule to Connect | Support (Optional Feature) | Not Support |
| DDNS IP Update | Not Support | Not Support |
| SMS IP Update | Not Support | Support |

For users previously using TMN-51T devices, to adapt to T61 Smart Modem is simple and straight forward. Follow the following steps, your device will be ready and up running within minutes.

- **Step 1:** Request from us the latest Center Manager Software
- **Step 2:** Configure the [serial interface](#) to your desired settings.
- **Step 3:** Set [Data Service Address & Port Number](#) same as your original data center IP address and port.
- **Step 4:** Set [Command Service Address](#) same as your original data center IP addresses well.
- **Step 5:** Open one additional internet port at your data center and configure that port number as [Command Service Center Port Number](#).
- **Step 6:** Configure other relevant settings as your original TMN-51T device.
- **Step 7:** Save your settings and reboot.

Now your T61 Smart Modem is ready for operation.

9 Application Notes

9.1 T61 Firmware Update

For the cases that there is a need to patch up the firmware of T61 devices, Center Manager software provides two convenient ways of doing it. One way is to use direct wire. It is a faster way but devices need to be connected to Center Manager using RS232 cable. Another way is to update via TCP connection. This is a slower but it becomes very handy if the devices are deployed at remote. In both cases, Center Manager software is mandatory. Please refer to the following sections for more details.

9.1.1 Direct Wire Firmware Update

- Contact us to get the latest firmware. The file should be named “main.bin”. Save the file in a directory.
- Select “Direct Wire Configuration...” from “Configuration” Tab.
- Power up the T61 device
- Select the COM port connecting the T61 device to your PC and click on “Connect” button
- Wait for the device to be connected, which will be reflecting after “Device Status”.
- Click on “Firmware Update” button which becomes available when device is successfully to Center Manager.

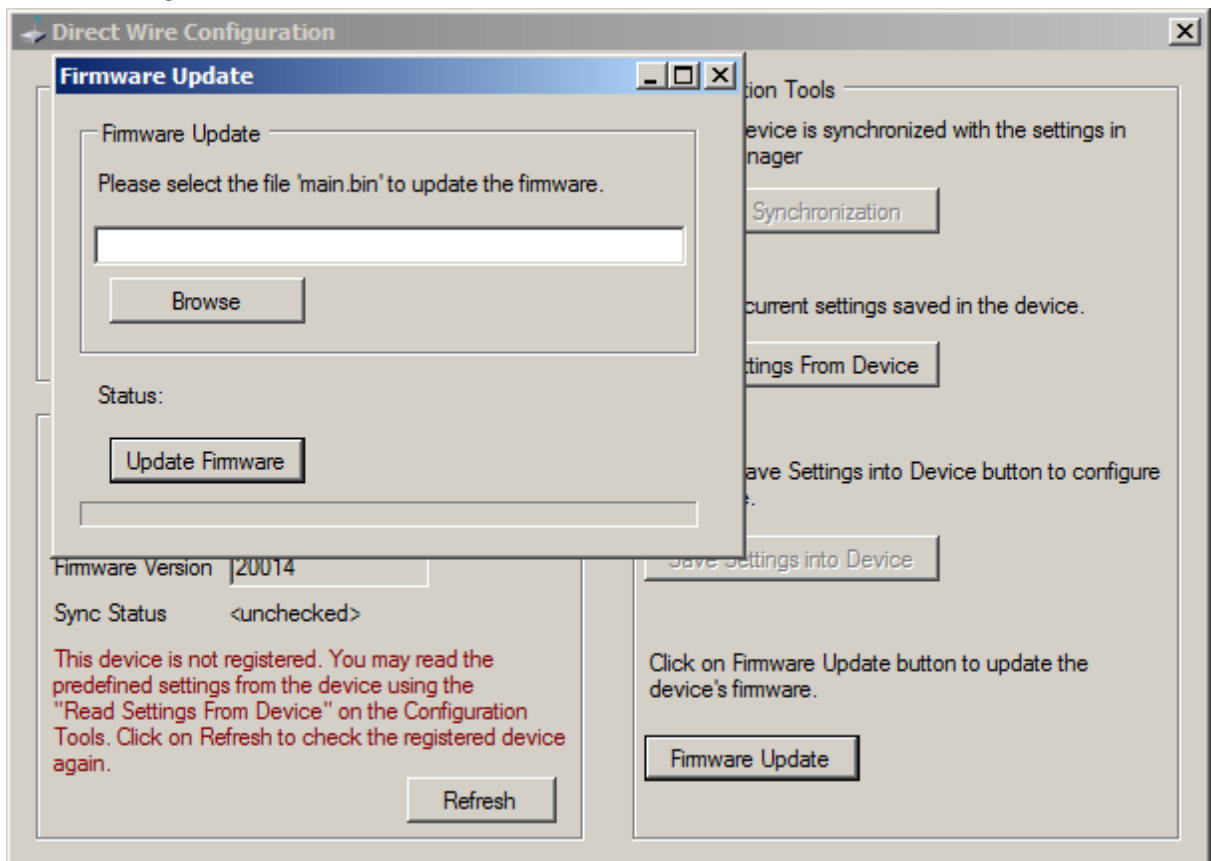

- Browse to select the firmware file saved and click on “Update Firmware” button.
- When the update is finished you will see the following notice and please click on “OK” to proceed. Otherwise, if it notices that firmware update is not successful, you can simply do it

again.

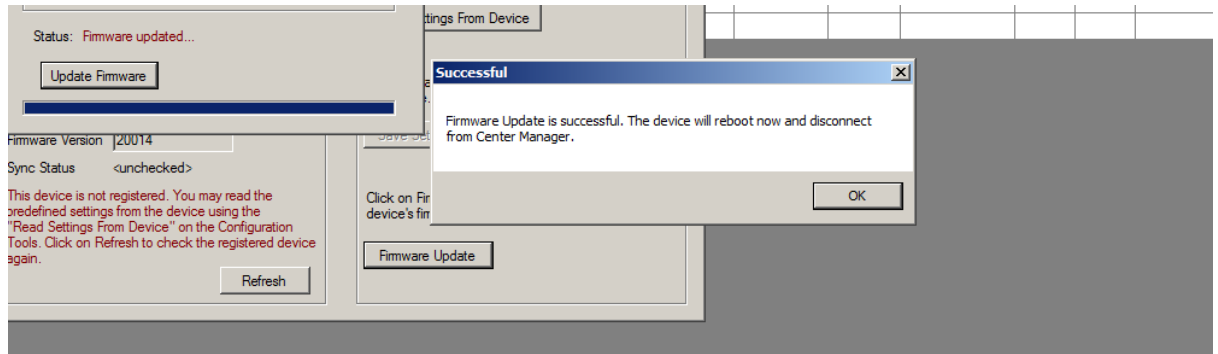

- Do not use Center Manager to connect to device immediately, it takes few seconds for the device to update its firmware. User can observe the LED blinking. Once it starts blinking once every second, it means the firmware updating is done.

9.1.2 Firmware Update Over-The-Air

- To update device firmware over the air, it is mandatory to have device command line connect to Center Manager software as a TCP client.
- Contact us to get the latest firmware. The file should be named “main.bin”. Save the file in a directory.
- Make sure the T61 device is connected to Center Manager. Command Line Status of the device should show “Online” as the picture below.

| Command Line Status | Data Line Status |
|---------------------|------------------|
| Offline | Offline |
| Online | Online |
| Online | Online |

- Go to “Tools” -> “Firmware Update” -> “GPRS...”
- Select and highlight the target device which should be showing online and click on “Firmware Update” button.
- Browse and select the firmware file saved and click on “Firmware Update” button.
- The process may take up to 10 minutes to finish depends on the air traffic.
- If the updating process stops half way with error message “update timeout”, it means the network currently is not ideal. Devices will not be affected by non-successful updates.
- When the updating is finished, the status in Wireless Firmware Update window will show “Firmware update successful...” The device will reset and reconnect back to the server again.

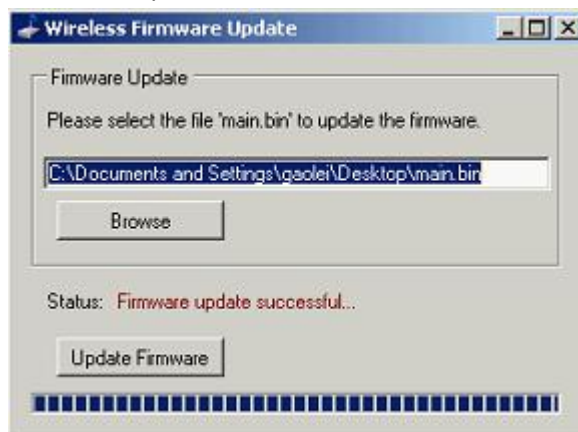

9.2 T61 Digital Input Configuration (Optional Features)

This section explains how to use the digital input of T61 Smart Gateway for your application. As mentioned in section [4.3 4-Pin Micro-Fit Interface](#), one input interface is available in T61 for external applications. To utilize this input interface, one external wire is needed to connect to the micro-fit open socket. The micro-fit socket of the power supply shipping out as standard kit set will not have extension wires for input and output. If it is required, you can contact us before placing the order. For customizing the extension wires, please use micro-fit 3.0 female crimp terminal.

This digital input is monitored constantly. During normal operation, when alarm feature is enable, an SMS or/and a GPRS message will be immediately sent out after [confirming the alert](#). It may take a few seconds for user to receive the alert. The alert message is only sent once upon a state change from normal to alarm. If afterwards the device remains in alarm state, no repeated messages will be sent out. T61 device will start monitoring the digital input when it successfully sets up as a server or connects to remote server. When it is busy setting up connection, it will not be monitoring the input interface.

9.2.1 Connection

Input interface of T61 Smart Gateway has its internal $1M\Omega^1$ pull-up resistor pulling up to 1.8V. This means that, if the input is not connected to anywhere device will always read HIGH. For applications using other voltage ratings, a voltage divider circuit can be used. Please take note that output impedance of the circuit connecting to T61 should be less than 100K Ω .

9.2.2 Configuration

To enable Digital Input Alarm feature, the input needs to be set to digital mode by disabling the Analog feature. Please keep in mind that for T61, either DI or AI but not both can be enabled at the same time.

- From your terminal software, select [8: I/O Setup](#) -> [1: AI Monitor Setting](#). And change the setting to 0, to disable the AI feature.
- Select [8: I/O Setup](#) -> [4: Input Alarm Setting](#). And change the setting to 4 or 5.
- Select [8: I/O Setup](#) -> [5: Alarm Option](#). Change the setting according to your application.
- Select [8: I/O Setup](#) -> [6: Input Sensitivity \(sec\)](#). Change the setting according to your application requirements.
- If sending to SMS is enabled, one user mobile number is needed. Select [7: Recovery Setup](#) -> [5: User Phone Number](#). Change the setting accordingly.
- Save the settings and restart the device.

9.2.3 Testing

To test this feature, the easiest way is to follow the configuration steps and set the [Input Alarm Setting](#) to DI-Normally Close. Then start the device. Once the device connects to server or sets up as server successfully, it will start monitoring the digital input. Few seconds later there will be an SMS sent to the configured user phone number. A sample SMS will be "Alert: Blk23 Device Digital Input High!" Here "Blk23" is the configured [device name](#) in this example.

¹ For Hardware version 1.2.

9.3 T61 SMS Features (Optional Feature)

When T61 Smart Gateway is programmed as smart modem, it is able to accept simple SMS control and configuration. This feature will be in place provided that SIM cards applied in applications are SMS enabled. Please make sure that do not flood T61 devices with SMSs. When module memory is full, it will not be able to receive any SMS until a reset. Incoming SMS will be stored at the first SMS memory slot and will be deleted after being read by T61 device. Please take note that SMS feature will only be functioning when the device is not setting up connection. When device is busy setting up connections, incoming SMS may interfere with the process. To avoid disturbance from random SMS, SMS features are disabled during connection setup.

9.3.1 Reset T61

- **Command:**
 - "T++"
- **Requirement:**
 - Center Phone Number is configured as "0" **OR**
 - Center Phone Number is not empty and incoming phone number matches it **OR**
 - User Phone Number is not empty and incoming phone number matches it.
- **Effects:**
 - T61 device will reset itself automatically
- **Replay:**
 - "OK"

9.3.2 Turn ON Digital Output

- **Command:**
 - "TON"
- **Requirement:**
 - Digital output is not disabled **AND**
 - Center Phone Number is configured as "0" **OR**
 - Center Phone Number is not empty and incoming phone number matches it **OR**
 - User Phone Number is not empty and incoming phone number matches it.
- **Effects:**
 - Application PIN connected to digital output will be connected to ground.
- **Replay:**
 - "OK"

9.3.3 Turn OFF Digital Output

- **Command:**
 - "TOFF"
- **Requirement:**
 - Digital output is not disabled **AND**
 - Center Phone Number is configured as "0" **OR**
 - Center Phone Number is not empty and incoming phone number matches it **OR**
 - User Phone Number is not empty and incoming phone number matches it.

- **Effects:**
 - Application PIN connected to digital output will be left open.
 - If the digital output is configured as input trigger, the alarm will be disarmed when receiving “TOFF” SMS.
- **Replay:**
 - “OK”

9.3.4 Configure Server IP and Port

In the following, DC stands for Data Center, CC stands for Command Center.

- **Command:**
 - “TIP:<DC IP>:<DC Port>:<CC IP>:<CC Port>” (Configure both connection)
 - “TIP::<CC IP>:<CC Port>” (Configure Command Line connection)
 - “TIP:<DC IP>:<DC Port>” (Configure Data Line connection)
- **Requirement:**
 - Center Phone Number is not empty OR “0” AND sender phone number matches Center Phone Number OR
 - User Phone Number is not empty AND sender phone number matches User Phone Number
- **Effects:**
 - Device will save the settings in flash memory and reboot
 - If device is in TCP server mode, device will change setting to TCP Client and save in flash memory before reboot
- **Replay:**
 - “OK”

For more information, please visit

<http://www.tcam.com.sg> or <https://www.facebook.com/TcamTechnology>

TCAM TECHNOLOGY PTE LTD

2 Kaki Bukit Ave 1 #05-04 Singapore 417938

Tel: (65) 67461930; Fax: (65) 67461938;

Website: www.tcam.com.sg;

Company Reg No: 200103565N; GST Reg No: 20-0103565-N

